

**WARNING:** Any furniture that is not anchored to a wall has the potential to tip over in certain circumstances, i.e. if a child attempts to climb up on the furniture or in the event of an earthquake. Accordingly, we recommend that all furniture is anchored to a wall.

# ASSEMBLY INSTRUCTION

FZ0010010 V. 210225.01

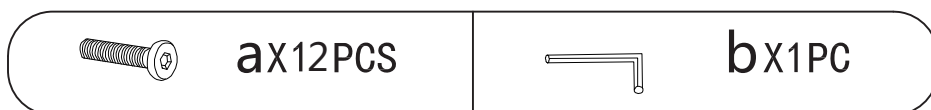
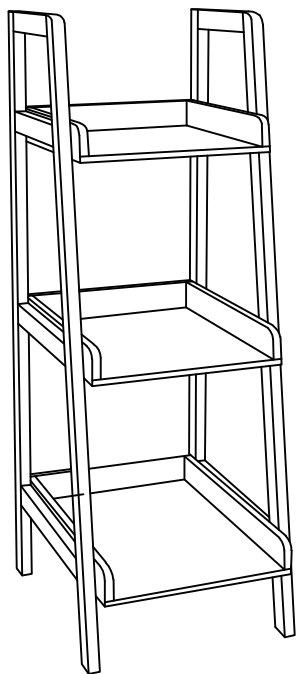

**!** Scanning the QR code to open assembly instructions.

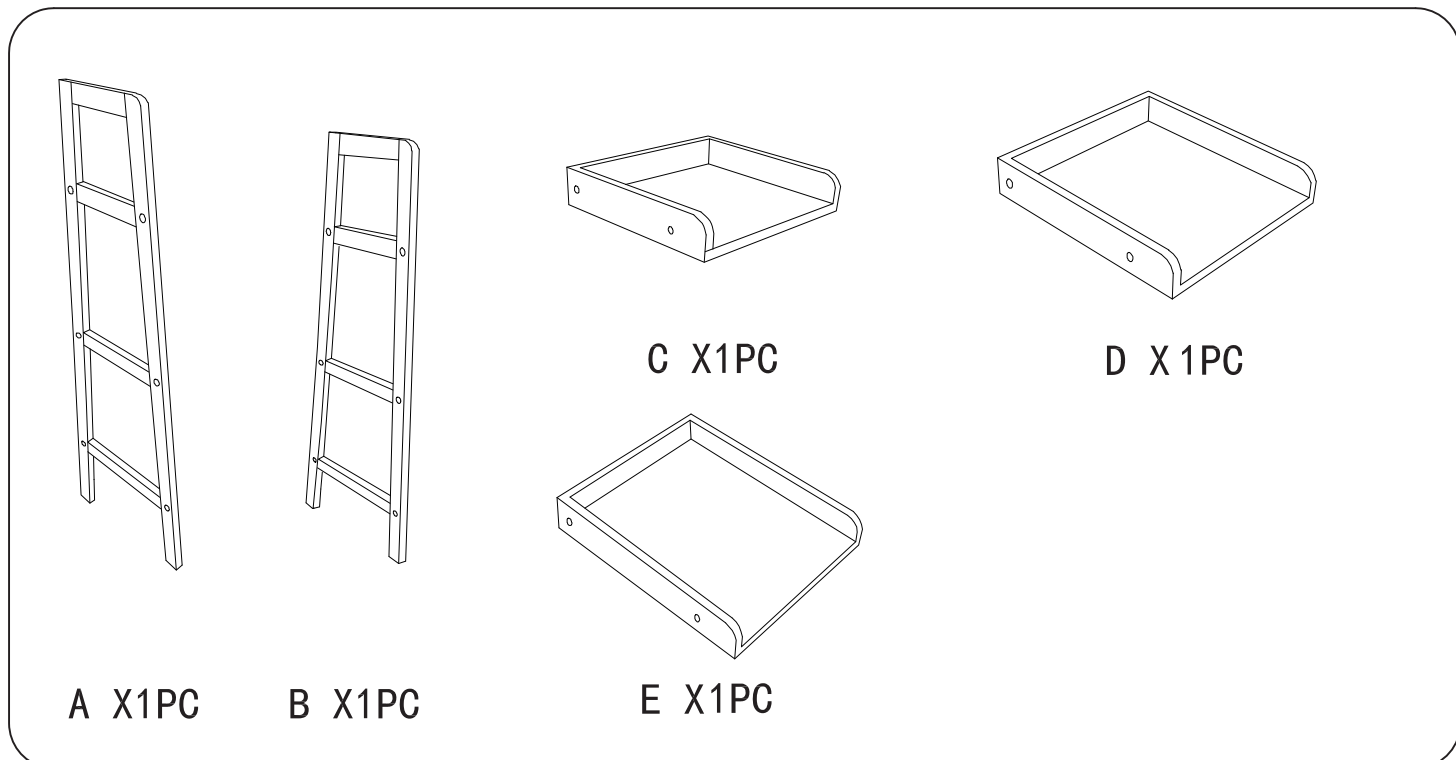



## SAFETY INSTRUCTION

# WARNING

Children have died from furniture tipover.



- (a) always secure this furniture with an anchor device;
- (b) never allow children to stand, climb or hang on drawers, doors, or shelves;
- (c) never open more than one drawer at a time;
- (d) place heavy items down low;
- (e) never place a television on this furniture.

# USER MANUAL

Thank you for choosing our product. We hope you will find the instructions on this user manual clear and easy to follow. If you take a few minutes to look through it, you'll learn how to assemble and use of your new unit for maximum enjoyment.

This User Manual will provide basic instructions and safety guide for this products. After you have finished reading the instructions, please keep this manual in a safe place for future reference.

Should you ever experience a problem with of any our products, please fell free to contact us.



## SAFETY INSTRUCTION

**FAILURE TO COMPLY WITH OR OBSERVE ALL ASSEMBLY, SAFETY AND OPERATING INSTRUCTION AND WARNING REGARDING THE USE OF THIS PRODUCT MAY RESULT IN SERIOUS INJURY.**

The safety of our clients and users is our primary concern. To ensure safe operation, please read this instruction carefully.

**WARNING:** Any furniture that is not anchored to a wall has the potential to tip over in certain circumstances, i.e. if a child attempts to climb up on the furniture or in the event of an earthquake. Accordingly, we strongly recommend securing all furniture to a wall using the anti-topple wall bracket supplied.

We have provided the fittings for attaching the wall bracket to the unit, but due to the different types of walls you might have, we not provided the fitting for attaching the bracket to your wall. You should first identify the type of wall you intent to fix the product to and then contact your local hardware store to get the appropriate fixings.

When attaching to walls always consider the position of any electrical cables or water pipes nearby.

# WARNING

FAILURE TO FOLLOW THESE BASIC STEPS CAN LEAD TO DAMAGE THAT IS NOT COVERED BY YOUR WARRANTY

1

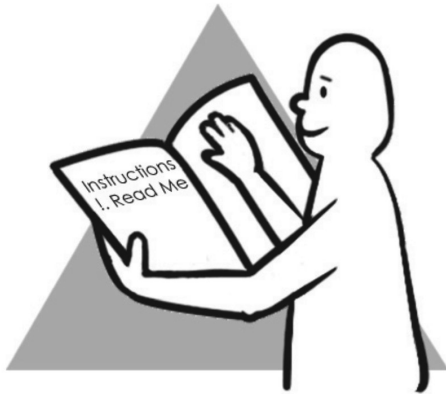

Read Instructions carefully. Check no parts are missing.

2

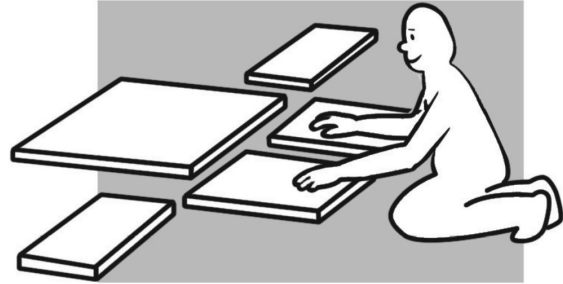

Lay out all of the components on a soft surface as if you were preparing to do a jigsaw puzzle.

3

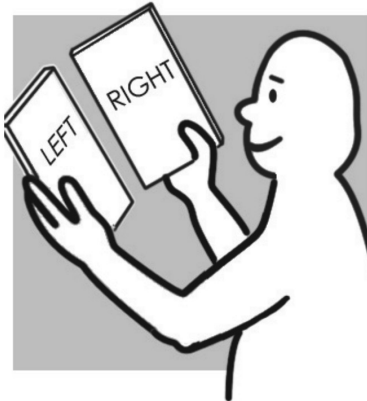

Carefully identify each component, especially those that are similar. The most common mistake is getting things back to front.

4



Separate and identify each component from the hardware pack and rest each one in its proper location before fastening.

5

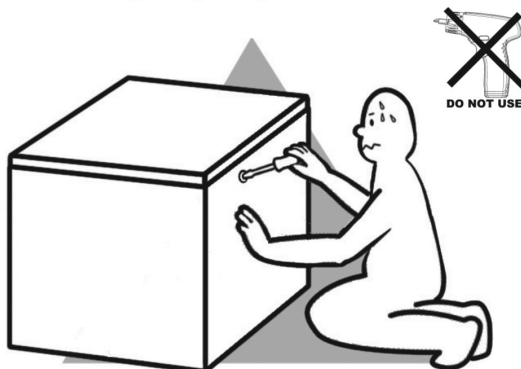

**DO NOT** fully tighten screws (leave slightly loose). When the item is fully assembled tighten the screws - but do not over tighten.

6

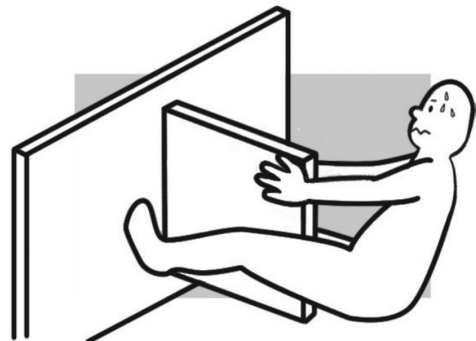

If glue is required **DO NOT** set until you are certain that the parts belong together.



## Safety and Care Advice

**Important** – Please read these instruction fully before starting assembly

Check you have all the components and tools listed are included.

Remove all fittings from plastic bags and separate them into their groups.

Keep children and animals away from the work area, small parts could choke if swallowed.

Make sure you have enough space to layout the parts before starting.

Do not stand or put weight on the products, this could cause damaged.

Assemble the item as close to its final position (in same room) as possible.

Do not place furniture direct in front of radiators, fires or any other source of heat.



Parts of assembly will be easier with 2 people.

Assemble on soft level surface to avoid damaging the unit or your floor.



We do not recommend The use of power drill/ drivers for inserting screws, as this could damage the unit.

Dispose of all packing carefully and responsibly.

## General Care And Maintenance

To ensure that you receive maximum pleasure from your new furniture, it is very important for you to care your products.

Maintain the furniture on a regular basis and in accordance with the instructions

Take care to prevent sharp object and avoid contact with chemicals e.g. cosmetics or hair products which may permanently mark the surface,

From time to time check that all the fitting are tight on this piece of furniture.

Always use coasters to protect surface from moisture and heat.

Take care when moving furniture- dragging pieces across the floor will damage the joints.

Avoid exposing your furniture to direct and prolonged periods of sunlight and heat sources as fading and cracking may occur.

## Cleaning And Care Of Products

Dust regularly with a clean dry cloth.

Wipe up any spills immediately with a damp cloth and then dry the surface with a clean dry duster.

Remove stubborn stains with weak washing up liquid solution and a damp cloth and dry with a clean dusters.

Do NOT use abrasive cleaners.

Do NOT clean with the following or products containing the following:  
Acetone(eg nail varnish remover), Ammonia(eg bleach) or Sodium hydroxide(eg Caustic soda, drain and oven cleaners). In the events of accidental contact rinse thoroughly with water

## General Information

If for any reason you should have problems with your products, Please retain your receipt as proof of purchase and contact the store from which you purchased it.

# A Guide to – Wall Mounting & Fixings

## Important Notes:

**Important:** When drilling into walls always check that there are no hidden wires or pipes etc.

## Wall Fixings:

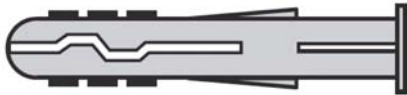

- because of the variety of different wall types, we have provided kind but may not exact fixings you will need to fix this product to the wall.

In this case, you must first identify the type of wall you intend to fix product onto and then contact your local hardware store to get the appropriate fixings.

Make sure that the screws and wall plugs being used are suitable for supporting your unit. Consult a qualified tradesperson if you are unsure.

## Hints:

- 1: **General rule:** Always use a larger screw and wall plug if you are not sure.
- 2: Ensure you use the recommended drill bit to match the wall plug and hole size.
- 3: Ensure you drill the hole horizontally, do not force the drill or enlarge the hole.
- 4: Take extra care when drilling high walls, ceilings and ceramic tiles. Ensure wall plugs are inserted beyond the thickness of the ceramic tiles to avoid the tiles splitting or cracking.
- 5: Ensure wall plugs are well fitted and are a tight fit in the drilled hole.

## Types of walls

You can use one of the following types of wall plug if your wall are mad of brick, breeze block, concrete, stones or wood.

### No.1 'General Purpose' wall plug

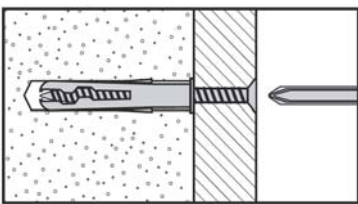

Generally aerated blocks should not be used to support heavy loads, use a specialist fitting in this case. For light loads, general purpose wall plugs can be used.

### No.2 'Cavity Fixing' wall plug

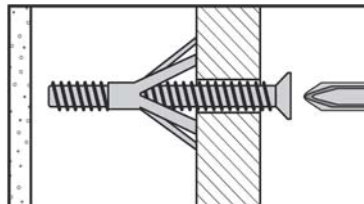

For use with plasterboard partitions or hollow wooden doors.

### No.3 'Hammerfixing wall plug

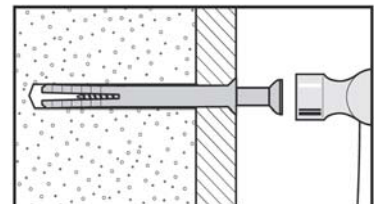

For use with walls stuck with plasterboard. The hammer fixing allows it to be fixed to the wall rather than the plasterboard. Always check the fixing is secure to the

### No.4 'Plasterboard' wall plug

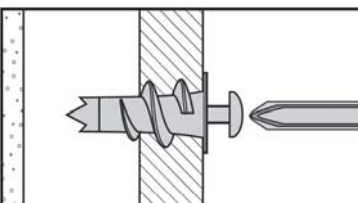

For use when attaching light loads on to plasterboard partitions.

### No.5 'Cavity Fixing-Heavy Duty' wall plug

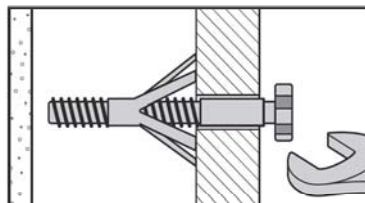

For use when fitting or supporting heavy loads such as shelving, wall cabinets and coat racks.

### No.6 'Shield Anchor' wall plug Heavy loads

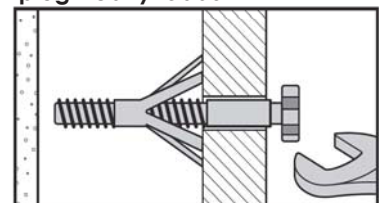

For use with heavier loads such as TV & HiFi speakers and satellite dishes etc.

# ASSEMBLY INSTRUCTION

FZ0010010

## Step 1

 a x12PCS

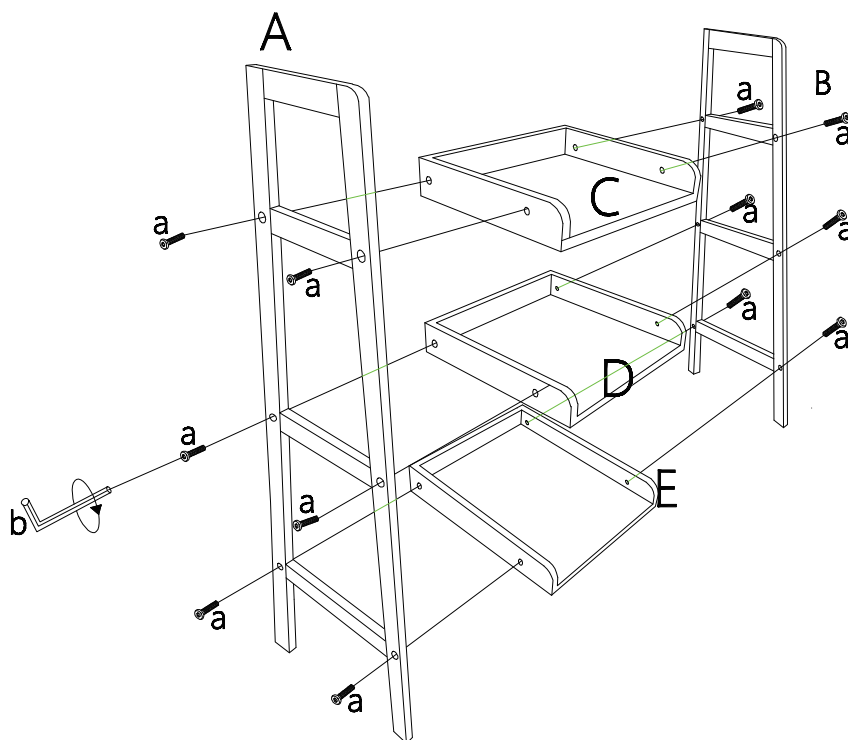

## Step 2

